

POS / ATM / Access Control

External Device Setup Guide

Ver 12.00.0

Digital Video Security System
Digital Video Recorder

www.cctvone.com

CCTVONE.

*All contents of this document may change without prior notice, and actual product appearance may differ from depicted herein.

Index

1. Preface – Feature	2
2. Device Connection	3
2-1. Direct Connection	3
2-2. Connection with POS Converter	4
3. DataScope	7
3-1. DataScope	7
4. POS Setup	10
4-1. Device Setup	10
4-2. Data Setup	11
4-2-1. Line Break	11
4-2-2. Transaction Break	12
4-2-3. Include	12
4-2-4. Exclude	12
4-2-5. Invalid	12
4-2-6. Replace	13
4-2-7. Event	13
4-2-8. Additional	13
4-3. Database Setup	14
4-3-1. Microsoft Access	14
4-3-2. SQL Server, SQL Server 2005, and MYSQL	14
4-4. Item Search Setup	15
4-5. XML Setup	17
4-6. Connecting Setup	19
4-6-1. Com Setup	19
4-6-2. Lan Setup	20
4-6-3. Display Setup	21
5. Text Data Search (Smart Search)	23
5-1. Item Search	25
5-2. Item Search (XML)	28
5-3. DVR-Net / DVR-Web	32

1. Preface - Feature

Our POS application integration will be unique and distinct from other DVRs in the marketplace because we provide a UNIVERSAL interface. Any external devices that transmit ASCII code based text data, through RS-232 or TCP/IP port, is able to be connected to our DVR, and the DVR will be able to record and overlay transaction data simultaneously. Utilities to create or modify POS protocols also provided.

This feature allows connecting any type of machine transmitting ASCII code text data directly to the DVR without any extra devices, such as text inserter.

On the DVR software, it displays transaction data on top of the video display with customizable display format, including font, size, color, position, and duration of display.

Not only will it display the data, but it will also allow to search through recorded video data by recorded text using Smart Search, based on the text string, such as NO SALE or VOID. It will pull up all relevant transactions and image, and playback from that position will save time and effort. In addition, Smart Search allows user to save an AVI clip right away.

This guide book contains instructions how to setup and utilize the above feature.

For any question you have, please contact to the following address. When you are sending your concerned matter, please include your company name and phone number with detail description.

E-mail: support@cctvone.com

Tel: 323-721-8999

Fax: 323-721-8599

www.cctvone.com

2. Device Connection

2-1. Direct Connection

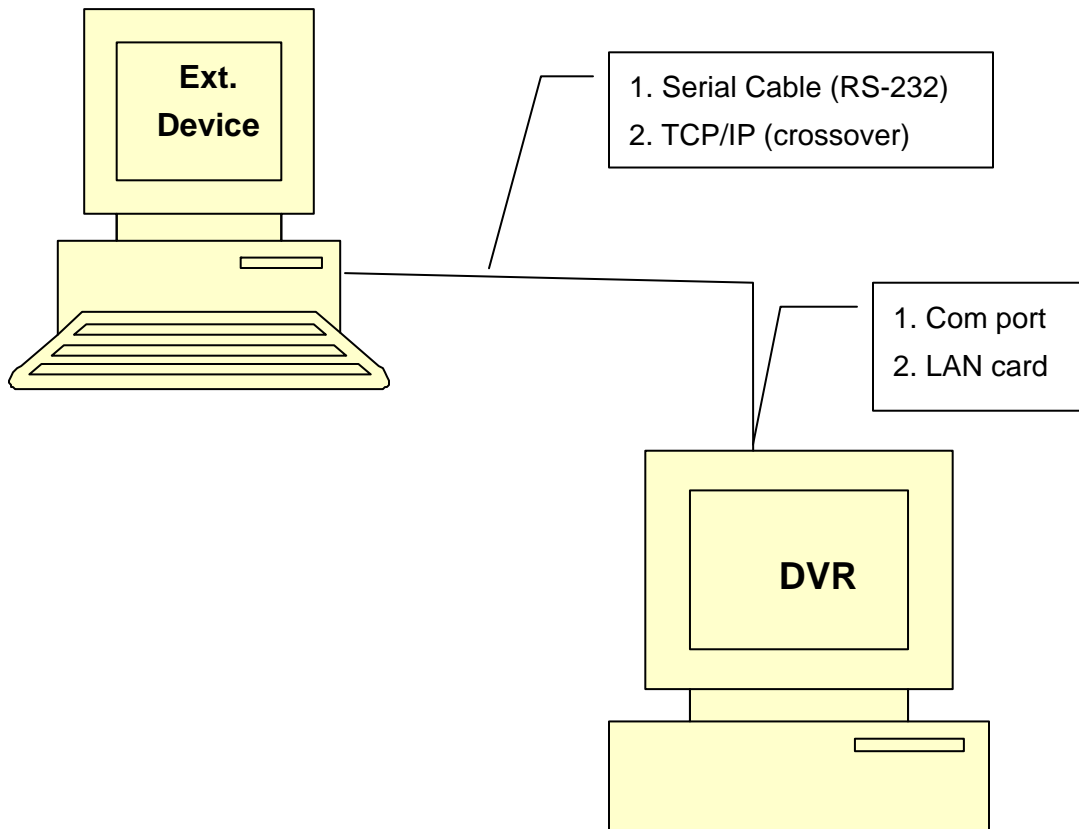

Serial cable connection: Reach of serial cable (RS-232) is within 50ft.

If there are multiple POS, expand the serial ports by adding serial expansion card in the DVR.

TCP/IP connection: In case of TCP/IP connection, the data, which transferred from POS to DVR, must be Text (ASCII Code) data. Please refer to POS manufacturer for outgoing port number and IP address of POS. If there are multiple POS, use hub or switch and regular cat-5 network cable instead of crossover.

2-2. Connection with POS Converter

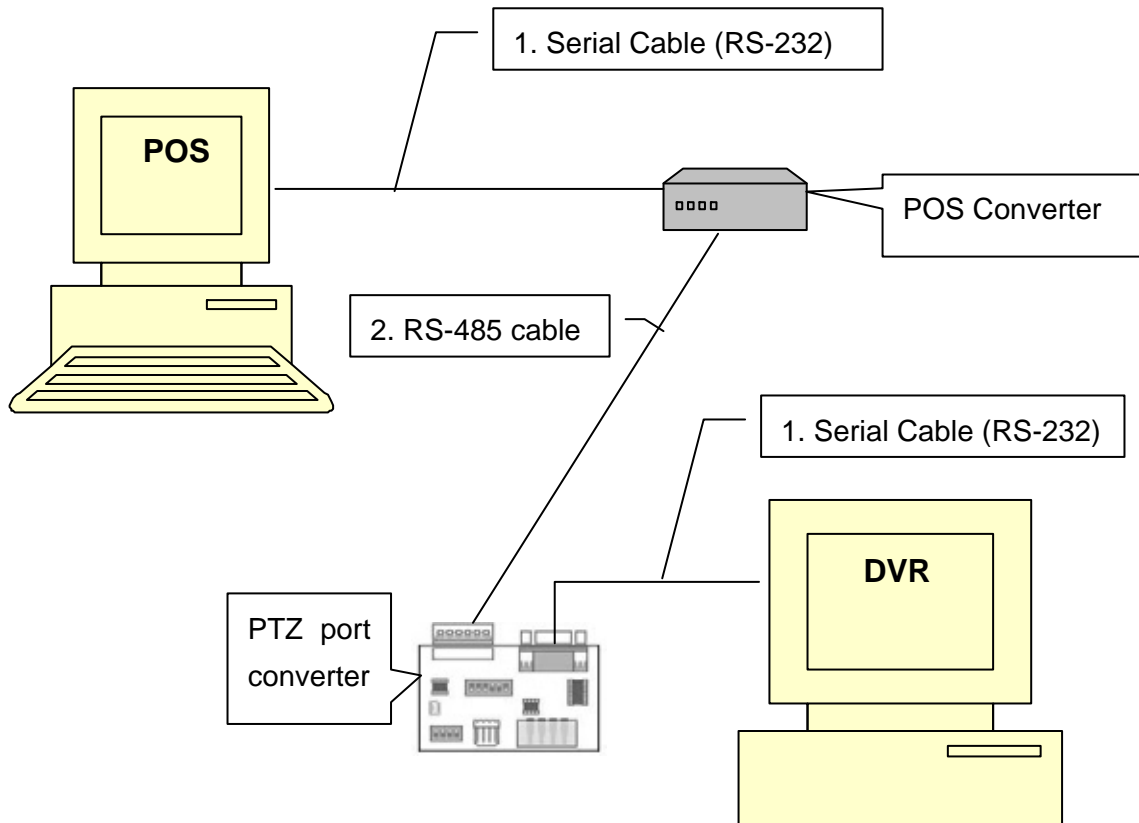

** This configuration only works with single device.*

If the device, which using RS-232 port for data transmission, is located farther than 50ft from DVR, POS port converter is needed since serial cable (RS-232) is limited by its short distance range.

The POS port converter converts RS-232 to RS-485, which has greater range up to 4000ft.

However, computers only accept serial cable (RS-232) connections; RS-485 has to be converted back to RS-232, using PTZ port converter provided with DVR products.

POS (serial port) → **POS port converter** (convert RS-232 to RS-485) →

PTZ port converter (convert RS-485 to RS-232) → **System** (serial port)

From POS, connect serial cable to the POS port converter shown in following picture.

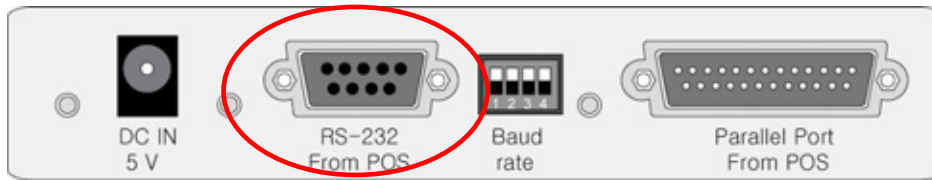

Use 5v, 1~2amp, 5.5mm barrel plug power supply for POS port converter.

Notice that next to the serial connector there is "Baud rate" dip switch. Followings are different switch setup for different data transfer rate. Change the Baud rate according to according to the POS.



Following picture shows connection of RS-485 from POS port converter.

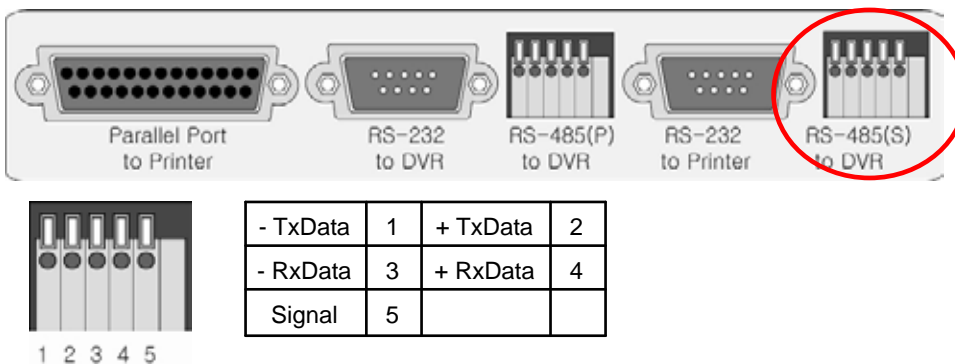

On the side of POS Converter, there are DIP Switches available to select the output signal type. SW1 and SW2 are used for Parallel port output, and SW3 and SW4 are for Serial port output



Depending on the output signal type, Switches must be configured as following:

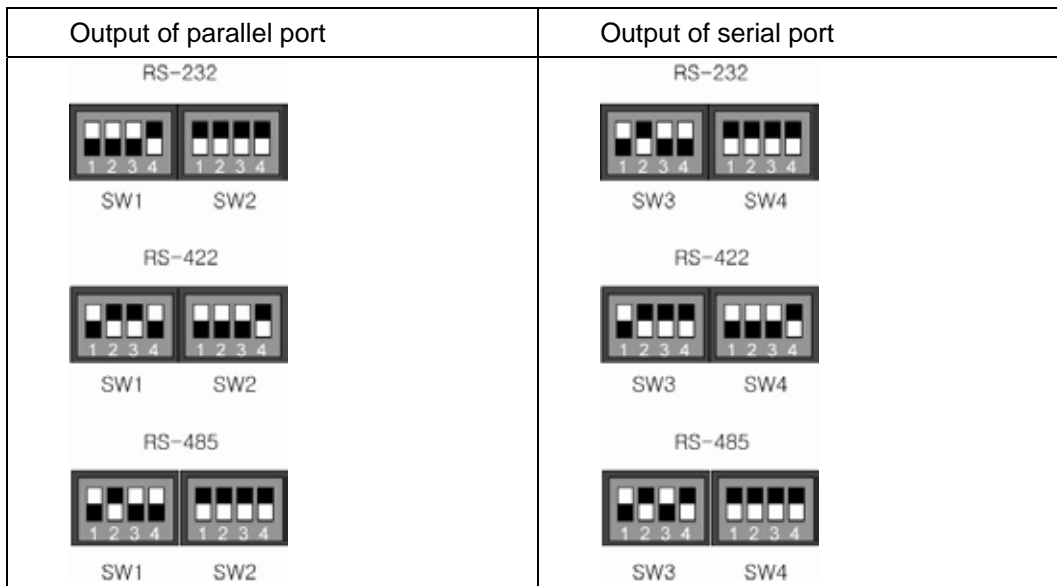

Following picture shows where the connection from POS port converter connects to the PTZ Port Converter.

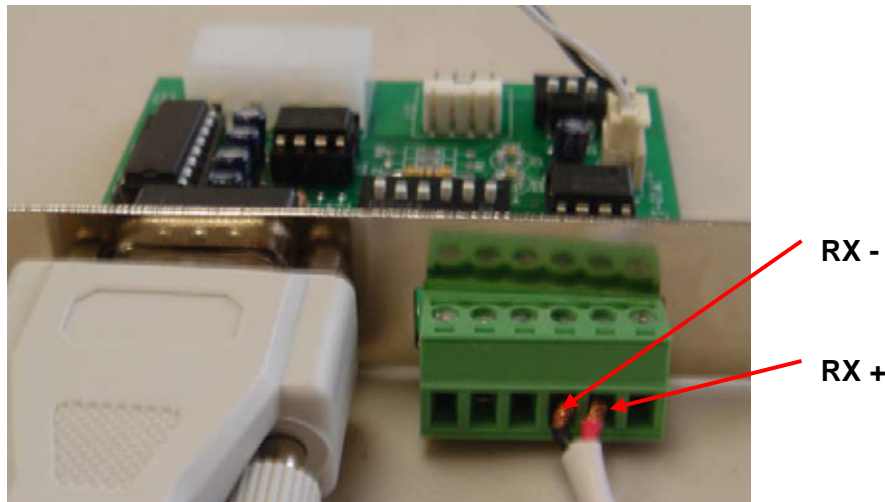

The serial cable here connects to computer's com1 serial port.

The PTZ Port Converter can be replaced with secondary POS Converter, if the PTZ Port Converter is used for PTZ cameras or another device.

In order to import data from multiple devices, each device requires separate serial port (Com port).

3. DataScope

3-1. DataScope

DataScope is a software designed to capture text data from external devices. Captured data using DataScope is analyzed to define the protocol.

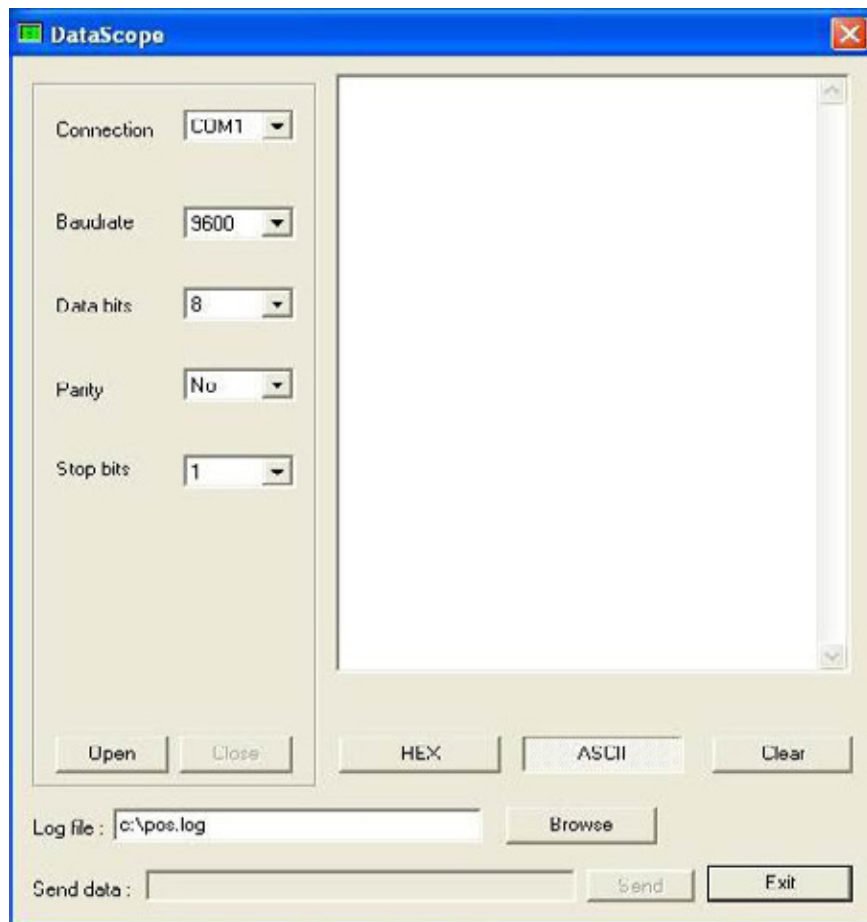

Connection: Choose connection between POS and DVR system.

Baudrate, Data bits, Parity, Stop bits: Setup properties of the serial connection.

Type, Port: Setup properties of the LAN connection.

Open: Click Open to capture the data from POS.

HEX, ASCII: Choose form of the data from POS. (HEX or ASCII)

Clear: Clear the screen.

Log file: Assign a location to save the log file. DataScope will create a log file with the name of the file assigned from here (*filename.log*) and an unformatted raw data file (*filename_data.dat*). Both files need to be analyzed to create a protocol.

Note: In order to obtain accurate information, do not make any changes to .dat file once it is created.

Screen shot of captured data in ASCII.

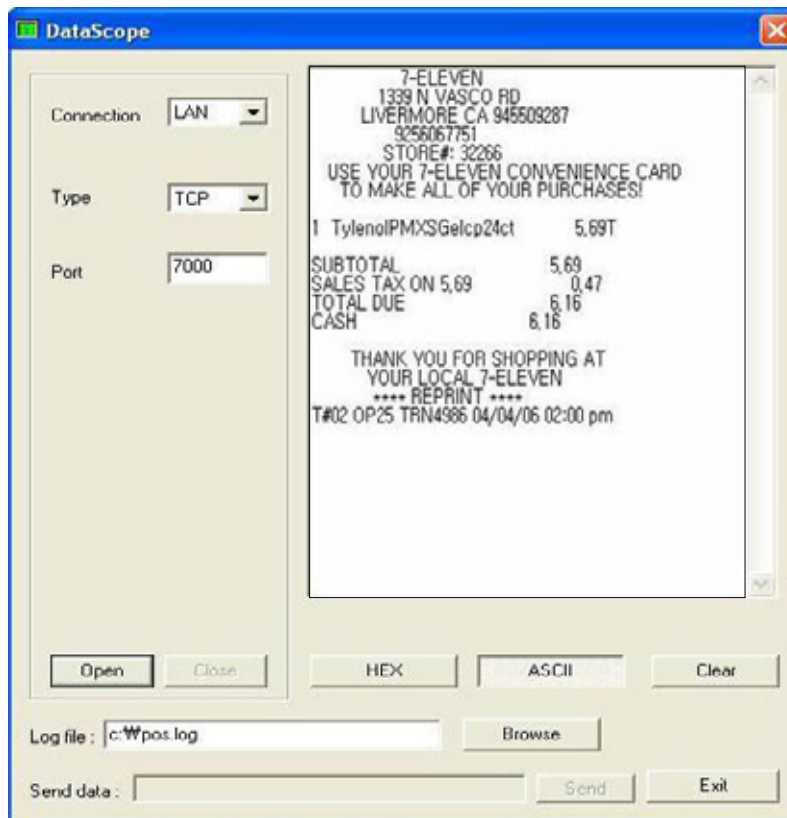

Screen shot of captured data in HEX.

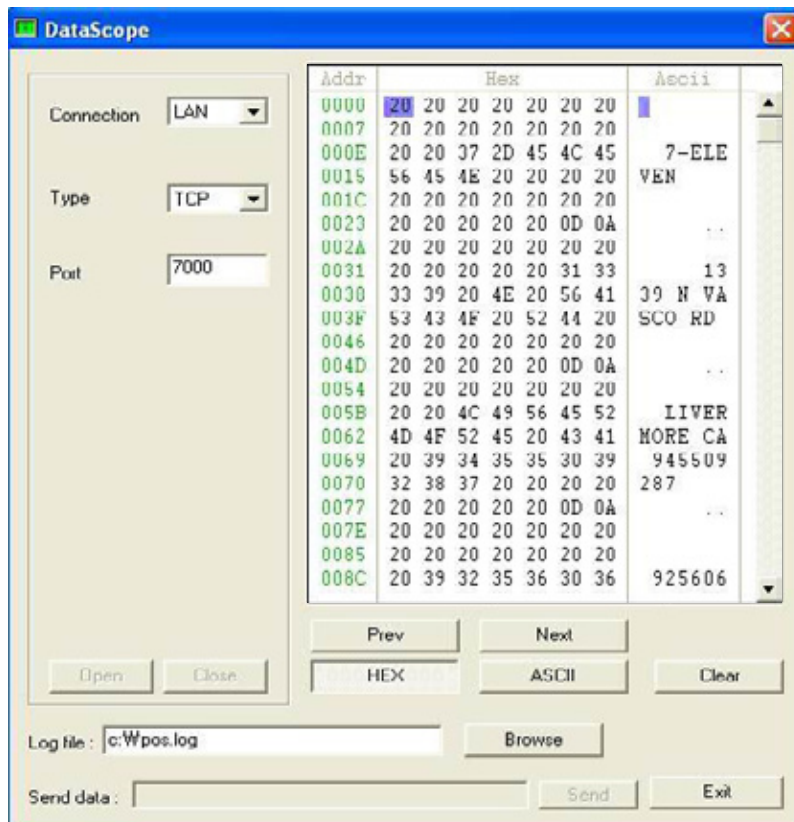

Log file is another useful source to see the captured data.

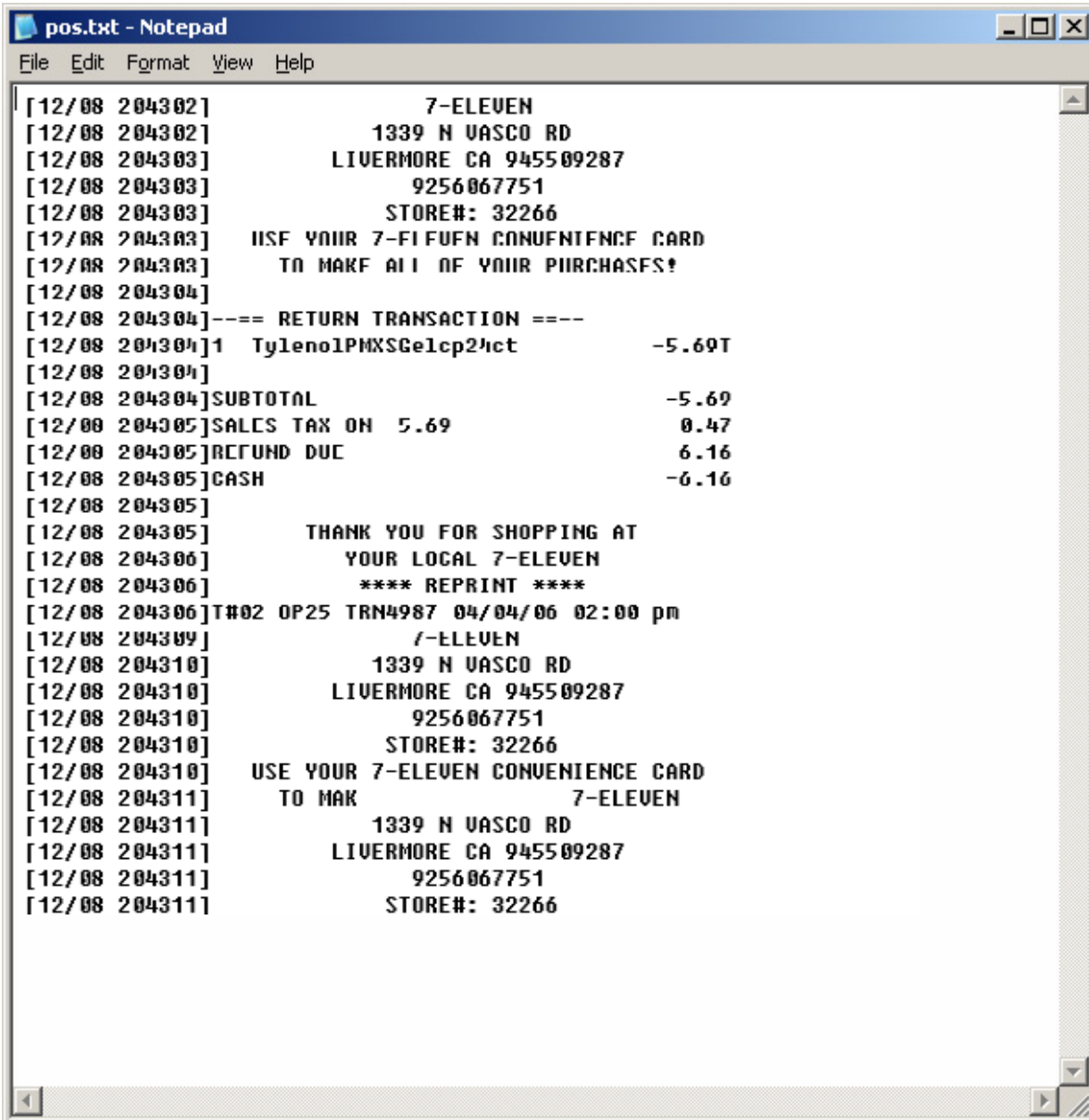

```
pos.txt - Notepad
File Edit Format View Help
[12/08 204302]          7-ELEVEN
[12/08 204302]          1339 N VASCO RD
[12/08 204303]          LIVERMORE CA 945509287
[12/08 204303]          9256067751
[12/08 204303]          STORE#: 32266
[12/08 204303]    USE YOUR 7-ELEVEN CONVENIENCE CARD
[12/08 204303]    TO MAKE ALL OF YOUR PURCHASES!
[12/08 204304]
[12/08 204304]---- RETURN TRANSACTION ----
[12/08 204304]1 Tyleno1PMXSGelcp2hct          -5.69T
[12/08 204304]
[12/08 204304]SUBTOTAL                      -5.69
[12/08 204305]SALES TAX ON 5.69              0.47
[12/08 204305]REFUND DUC                        6.16
[12/08 204305]CASH                             -6.16
[12/08 204305]
[12/08 204305]          THANK YOU FOR SHOPPING AT
[12/08 204306]          YOUR LOCAL 7-ELEVEN
[12/08 204306]          **** REPRINT ****
[12/08 204306]T#02 OP25 TRN4987 04/04/06 02:00 pm
[12/08 204309]          7-ELEVEN
[12/08 204310]          1339 N VASCO RD
[12/08 204310]          LIVERMORE CA 945509287
[12/08 204310]          9256067751
[12/08 204310]          STORE#: 32266
[12/08 204310]    USE YOUR 7-ELEVEN CONVENIENCE CARD
[12/08 204311]    TO MAK          7-ELEVEN
[12/08 204311]          1339 N VASCO RD
[12/08 204311]          LIVERMORE CA 945509287
[12/08 204311]          9256067751
[12/08 204311]          STORE#: 32266
```

Another way to see and analyze the data is to print the log file.

To create the protocol, run Device Setup program.

Usage of Device Setup program is described in section 4-1 and 4-2.

4. POS Setup

POS setup is available only if POS Patch is successfully installed. After installation of POS patch, "POS" button will be available on the setting, as following:



4-1. Device Setup

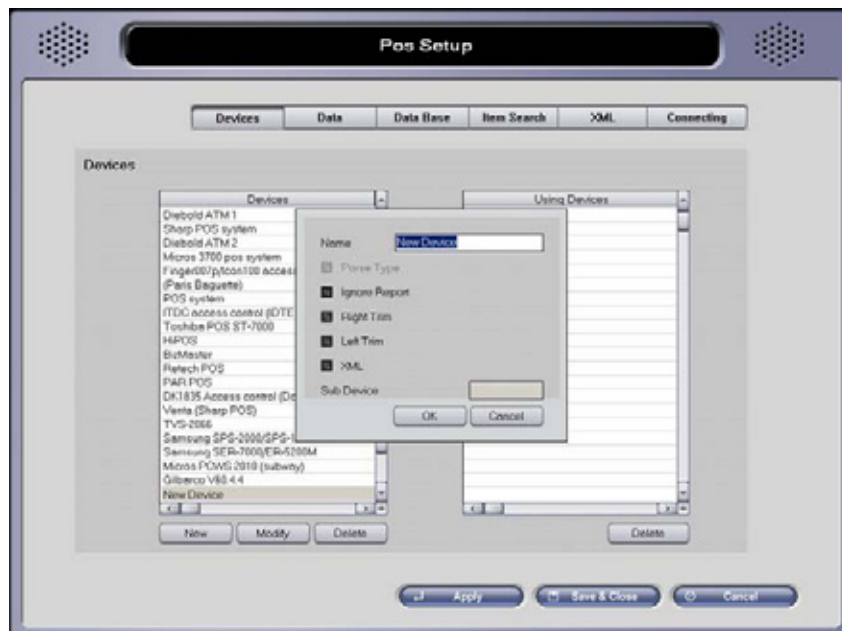

Select an appropriate POS devices or access controls and click ">>" button to register to the Map.

If the device is not listed, click on new and double click on the 'New Device' to change device name and properties.

4-2. Data Setup

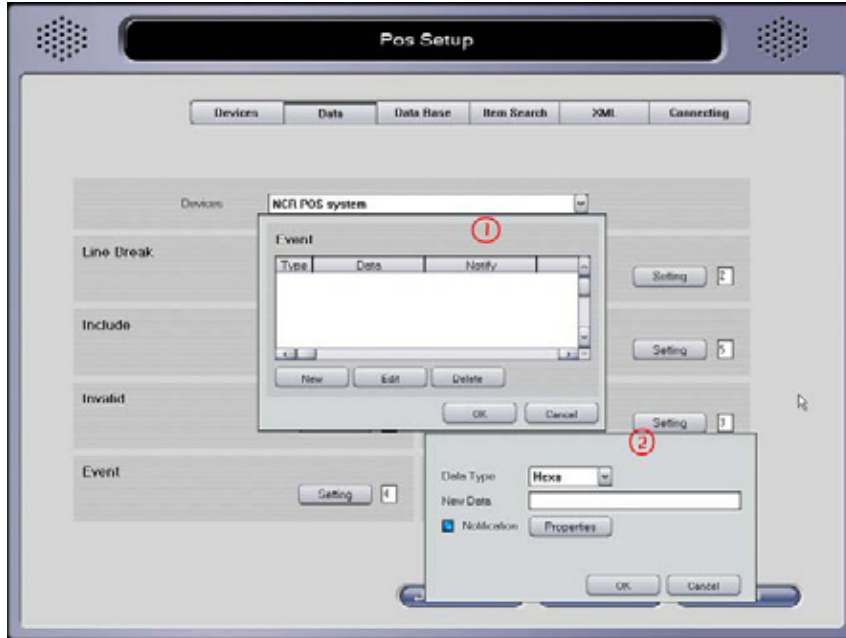

Set rules to analyze data from a device that is in 'Map' list. Numbers in the box after each 'Setting' buttons are indicating the priority. Rules will be applied ascending order, and the priority of Line Break and Addition rules are not adjustable.

Followings are instruction for each section.

4-2-1. Line Break

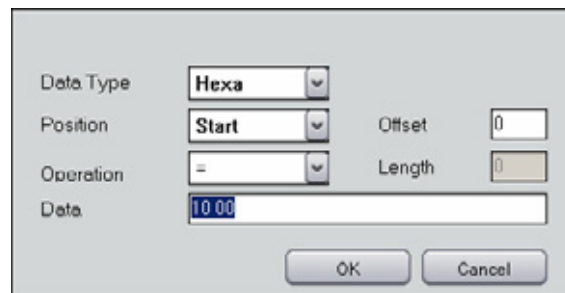
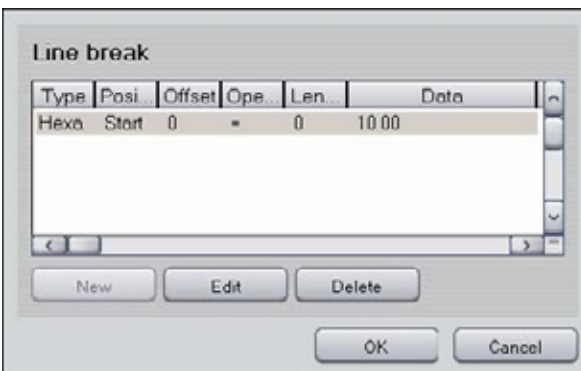

Set a rule for separating each line. Click 'Setting' on Line Break section to open the interface shown on left picture. The picture on the right is the interface for New or Edit.

Data type: Choose a type of data. Data types must be either 'Hexa' or 'Ascii'.

Position: Select a position to search the data string (ex. Start to search from the beginning)

Operation: Select an operator to be used when comparing 'Data' with data from POS.

Data: Set Data that will trigger the operation.

4-2-2. Transaction Break

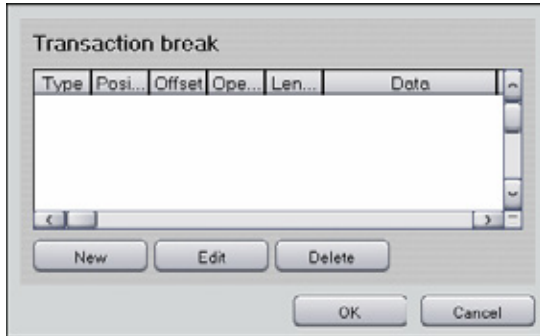

Set a rule for separating each Transaction.
Editing procedure is similar to Line break (4-2-1).

4-2-3. Include

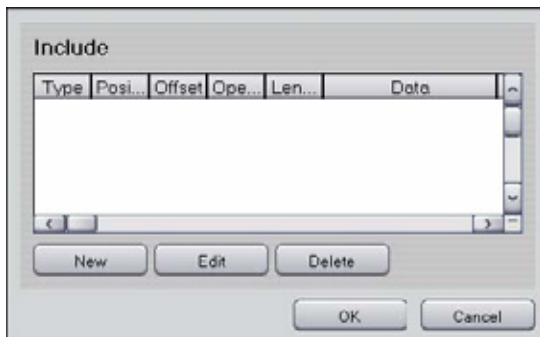

Set a rule for a line with a string or character to be displayed.
Editing procedure is similar to Line break (4-2-1).

4-2-4. Exclude

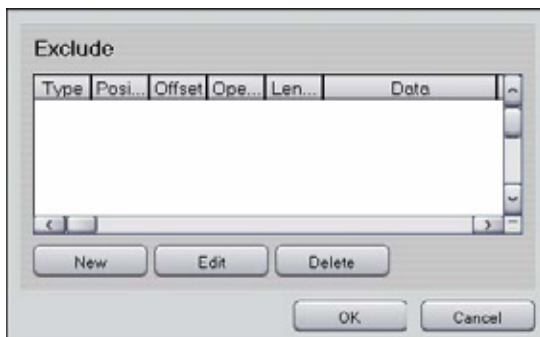

Set a rule for a line with a string or character to be concealed.
Editing procedure is similar to Line break (4-2-1).

4-2-5. Invalid

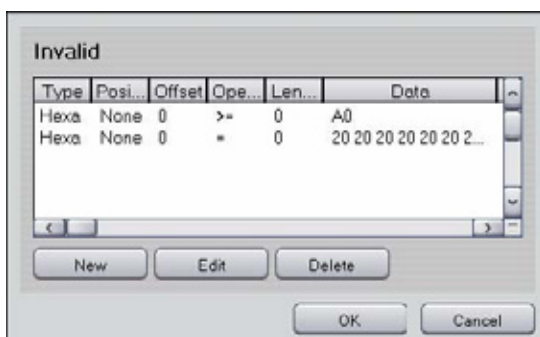

Set a rule to discard a string or character.
Editing procedure is similar to Line break (4-2-1).

4-2-6. Replace

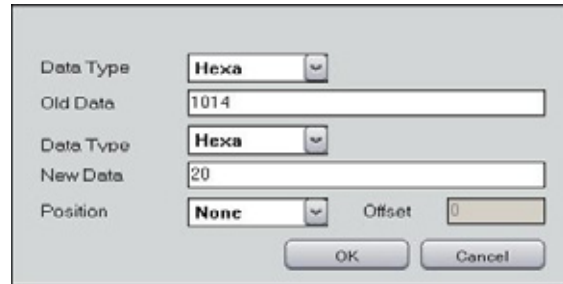
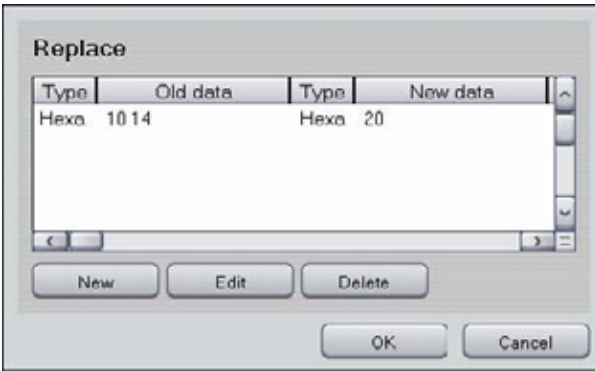

Set a rule to replace a word or character to another.

Data type: Choose a type of data. Data types must be either 'Hexa' or 'Ascii'.

Old data: Enter data string that needs to be replaced.

New data: Enter a new data string that will take a place of the Old Data.

Position: Select a position to search the data string (ex. Start to search from the beginning)

4-2-7. Event

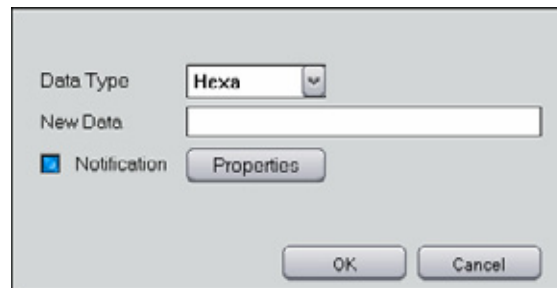
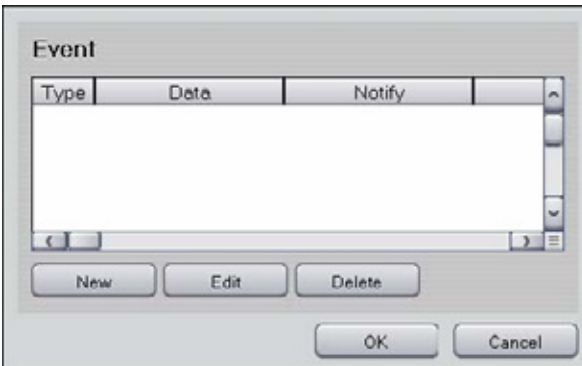

Set a rule to trigger a beep, mark or popup event.

Data type: Choose a type of data. Data types must be either 'Hexa' or 'Ascii'.

New data: Enter a new data string that will take a place of the Old Data.

Notification: Select a method of event.

4-2-8. Additional

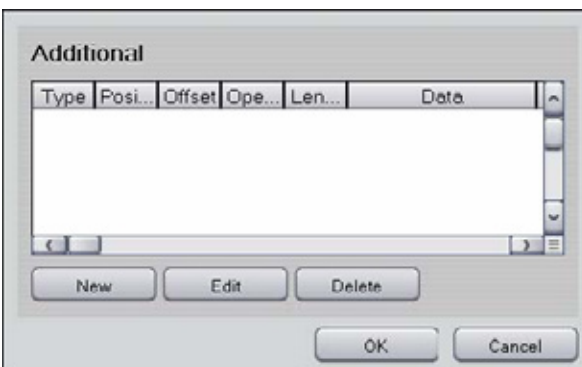

Set a rule to add a string or character.

Editing procedure is similar to Line break (4-2-1).

4-3. Database Setup

Database file(s) must be created for each devices registered under Device section.

Supported database type: Microsoft Access and SQL server, SQL Server 2005, MySQL

4-3-1. Microsoft Access

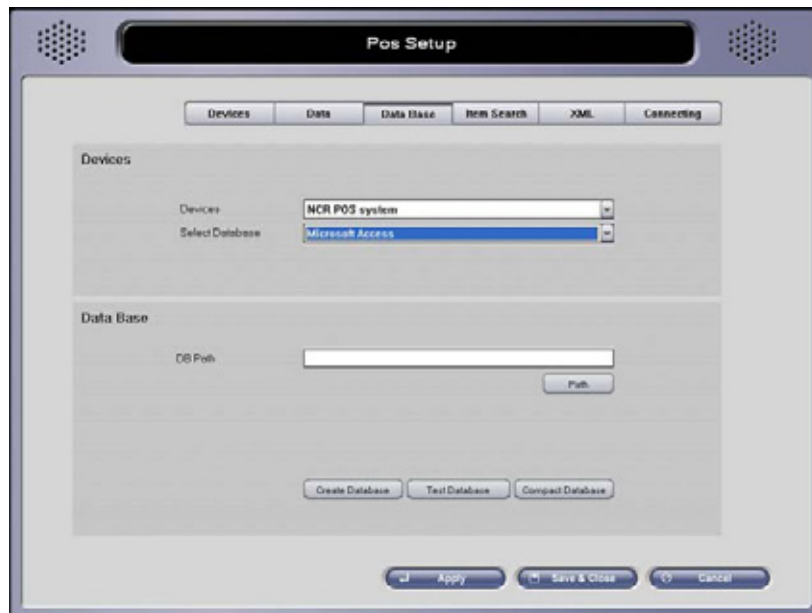

Select folder to create DB and click Create Database, Test Database, Compact Database in order to create database and test it.

4-3-2. SQL Server, SQL Server 2005 and MYSQL



Fill out SQL Server name, DB name, User name SQL server and, Password.

Click in order: Create Database -> Test Database.

4-4. Item Search Setup

Item Search allows users to register keywords ahead of time and use these keywords to search recorded text data transmitted from the external device. When searching for a specific item, the range of the quantity and the cost of the item can be used. (Accuracy of this feature is completely depending on the data input format of the device used.)

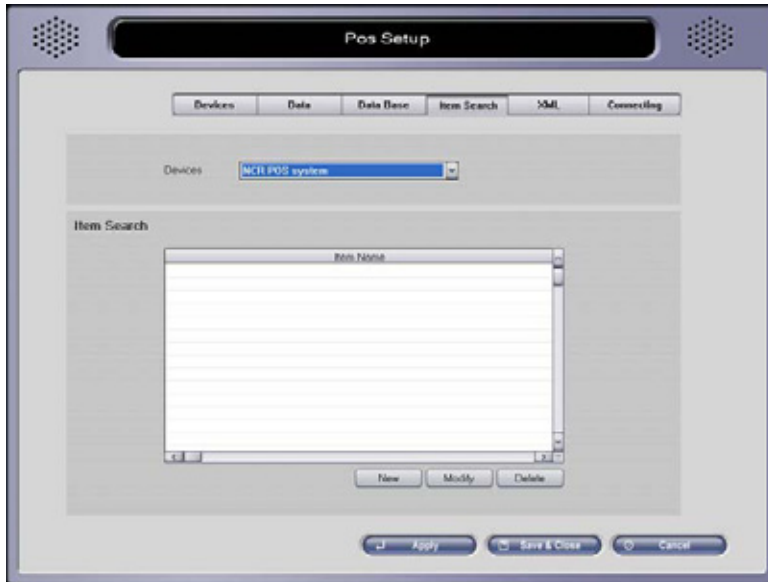

Devices: Select a POS Device.

New: Click to register an item.

Modify: Click to modify selected item.

Delete: Click to delete selected item.

The item registration window will appear as follows.

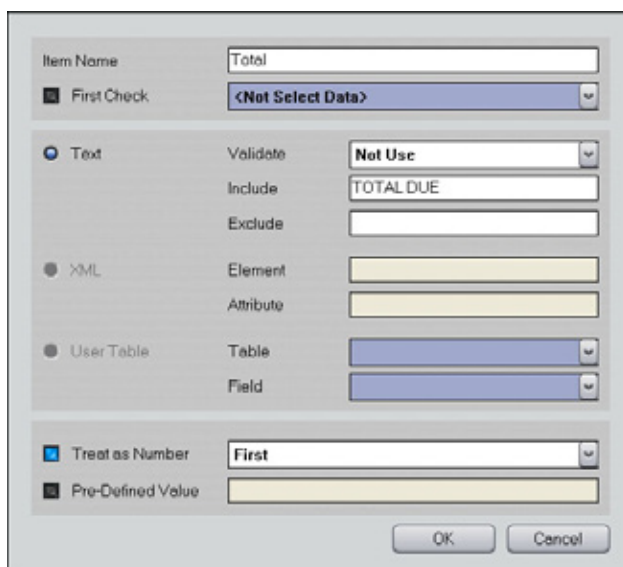

Item Name: Enter the name of the item that will be used from Item Search.

First Check: Select to perform the search using previously registered Item before searching for the Item. However, if the type of the search is XML or User Table, then First Check Item must have a Pre-Defined Value.

Text: Select to search item from text data input.

- Validate: Determines the validity of the text data input before searching for an item by checking whether the input data begins or ends with a specific character or number
 - Not Use: Select to disable this feature.
 - Start with Character: Select if the text data input starts with a character (including special characters.)
 - End with Character: Select if the text data input ends with a character (including special characters.)
 - Start with Number: Select if the text data input starts with a digit.
 - End with Number: Select if the text data input ends with a digit.
- Include: Enter the name of the item which will be searched.
- Exclude: If the text data contains the item, but it also contains undesired item, then enter the undesired item in order to exclude the text data from the search.

Note: The order in which items are searched is as follows: Validate -> Include -> Exclude.

XML: XML can only work if the data transmitted from POS is in **XML format and uses SQL Server 2005**.

- Element: Enter an element of XML data.
- Attribute: Enter the attribute of the element.

User Table: User Table can only work if the data transmitted from POS is in **XML format**, and Microsoft Access, SQL Server, or SQL Server 2005 can be used as the database. Note that "User Defined Table" from XML setting must be defined before using this feature.

- Table: Select a table that has been defined from XML setting.
- Field: Select a field of the selected table in which the search will look for the text data registered as Item Name.

Treat as Number: If a text data that contains the searching item also contains numerical data, then use the numerical data as a number.

- First: Select to use the first numerical data of the text line.
- Last: Select to use the last numerical data of the text line.

Note: Only Items that are registered as "Treat as Number" can be searched using a range of values.

XML search does not support "First" and "Last", and it recognizes the value of fields as a numerical data.

Pre-Defined Value: Select to define a searching condition ahead of time.

The system will perform another search for another Item from the search result under the Text search method.

4-5. XML Setup

XML configuration is used to receive XML data from POS or Access Control.

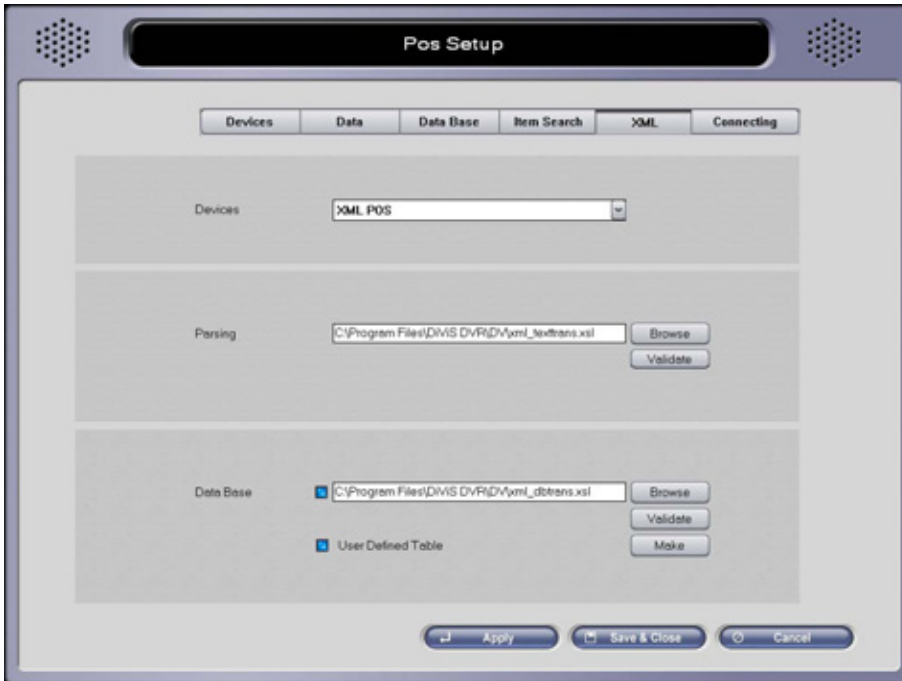

Devices: Select a POS Device (Only devices that support XML will be listed.)

Parsing: Select a XSL Transformation file which will be used to display only a desired field from the received XML data (Parsing is required for XML Equipments.)

- Validate: Checks to see if selected XSL Transformation file is valid.

Data Base: Select a XSL Transformation file which will be used to handle XML data as desired. (If database is disabled, the contents of the received data will stay the same as it was parsed by "Parsing".)

User Defined Table: Allows users to create a user-defined table from a desired XML formatted data that makes Item Search easier and faster.

- Make: Creates a Table. Please refer to the example on the next page.

Example: Users can create a User-Table as the following screen-shot if the data can be formatted as below using Parsing or Data Base

----- Data formatted by Parsing -----

```
<html>  
<TransactionType>...</TransactionType>  
<TimeStamp>...</TimeStamp>  
<Param Name="..." Value="...">  
<Param Name="..." Value="...">  
<Param Name="..." Value="...">  
<Param Name="..." Value="...">  
</html>
```

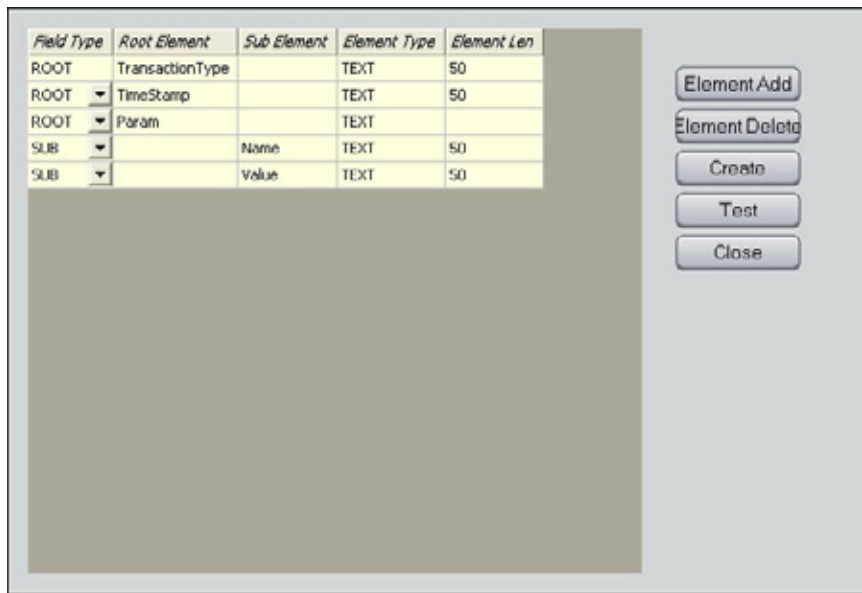

- Element Add: Adds an element.
- Element Delete: Deletes an element.
- Create: When finished defining a Table, click "Create" button to create the User Table on the database.
- Test: Tests the validity of the selected table.

4-6. Connecting Setup

Communication with External device can be established by both Serial port and TCP/IP.

Note: "Com Setup" and "Lan Setup" cannot be accessed while the Main Application is running.

4-6-1. Com Setup

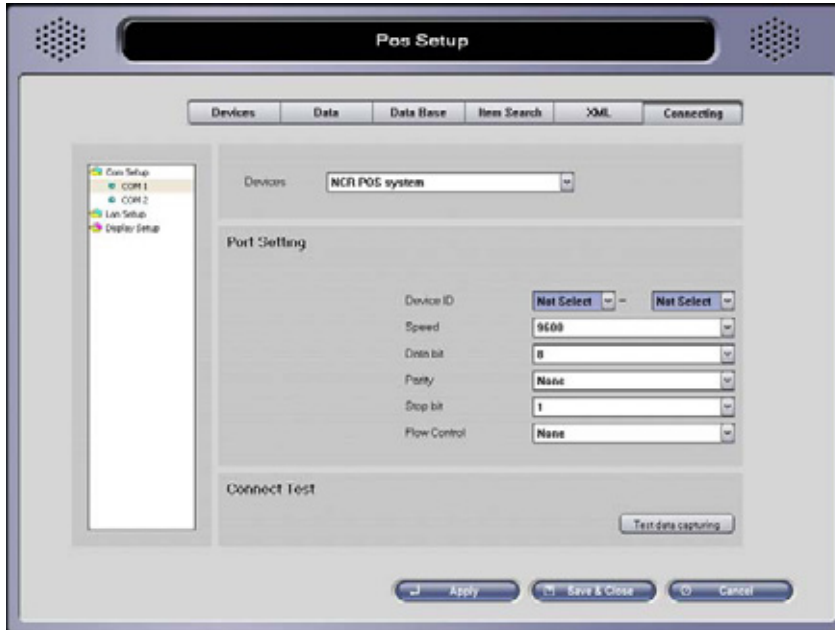

The list of the COM ports that can be used under the system will be listed on the left portion of the screen. Select the port where external device is connected to configure.

Note: If there are more External devices than available ports, COM port expansion card or USB to COM port converter may be used to add more ports.

Devices: Select a device that will be linked to.

Port Setting: Configure them the same way as the configuration of the external device. The default value displayed is a commonly used configuration.

- Device ID: Set the range of the ID in case that identical Access Controls are bundled together. This option is only available with certain Access Controls integrated with DVR products.

Connect Test: When all configurations are made, "Test Data Capturing" button can be used to check the data transmitted from the external device. If you are unable to check the transmission of date, make sure that the connection with external device and Port Setting are made correctly. (Test cannot be performed with Access Controls. The only way to verify the data is by running the Main Application.)

** If nothing comes up in Test data capturing, check the setting value and cable connection*

4-6-2. Lan Setup

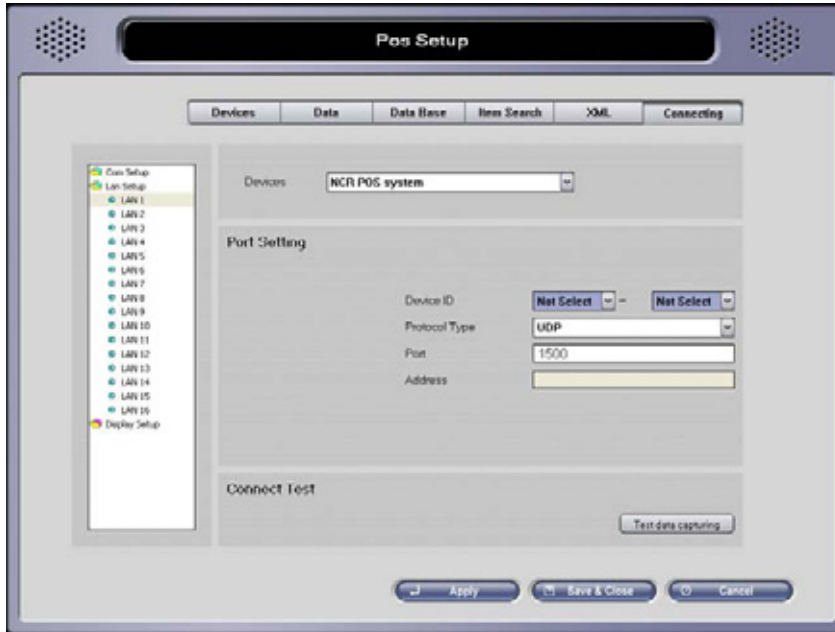

* Multiple external devices can be connected with a single TCP/IP connection.

Each device must be given a unique port number.

The connection with multiple external devices that support TCP/IP is possible using a single TCP/IP connection. Each external device must use different port number in case that multiple devices are connected to the system at the same time. Select an entry from LAN 1 to 16(32) from the list

Devices: Select a device that will be linked to.

Port Setting: Set this section same as the external device's configuration.

- Device ID: Set the range of the ID in case that identical Access Controls are bundled together. This option is only available with certain Access Controls integrated with DVR products.
- Protocol Type: Supports either TCP or UDP (if the external device supports both protocol types, UDP is recommended). Choose TCP Client for Access Controls, otherwise choose TCP Server.
- Port: Select the same port as the external device. If multiple external devices are connected through a LAN, then each device must use different ports.
- Address: Enter the IP address of the external device if TCP Client is selected.

Connect Test: When all configurations are made, "Test Data Capturing" button can be used to check the data transmitted from the external device. If you are unable to check the transmission of data, make sure that the connection with external device and Port Setting are made correctly. (Test cannot be performed with Access Controls. The only way to verify the data is by running the Main Application.)

* If nothing comes up in Test data capturing, check the setting value and cable connection

4-6-3. Display Setup

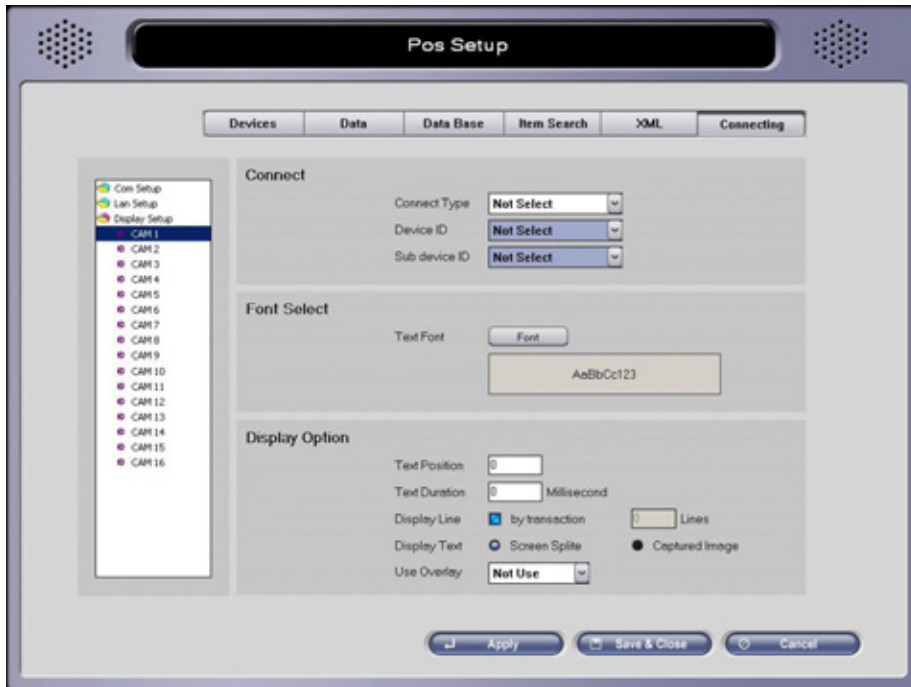

Allows users to set the font and display option of each camera that are linked to an external device.

Connect: Select a device that will be linked to the camera.

- Connect Type: Select a previously configured COM/LAN device number.
- Device ID: Select the ID of the device if available.
- Sub device ID: Select the ID of the sub-device if available.

Font Select: Click “Font” button to change the font, size, color, etc of the text data.

Display Option

- Text position: Enter the vertical starting position of the output. Default is set to top of the screen. As number increases, text will be displayed further from the top.
- Text duration: Enter the duration of text to stay on screen in milliseconds (1/1000 second.)
- Display lines: Check “By transaction” to display text data until the transaction break is reached. Unchecking “By transaction” and entering a numerical value in “lines” will force the system to display only given number of lines, and next text output will be displayed after clearing the screen.
- Display Text: Select lines of text data to be displayed and recorded on the image when the number of lines to be displayed exceeds the available height of the image displayed on the screen.
 - Screen split – the number of lines to be displayed at once will be automatically reduced to fit into the image displayed and scroll. Recording will be kept in same manner. This option will override the “lines” assigned at “Display lines” section if necessary.
 - Captured image - the number of lines of text data will be displayed and saved based on the height of the image recorded. If a text overlaid channel is displayed smaller size than actual recording resolution, text lines displayed beyond the height of the displayed image will be invisible. To make all text lines visible under this option, the text overlaid channel should be displayed properly.

- Use overlay:

- Not Use: Select to disable this feature (Recommended.)
- Use: Select to combine text and video input into one single image. (The text data might be displayed after the overlaying process depending on the product.)
- Hidden: Select to hide text data on main screen, but still record text data and make it searchable.

Note: Text outputs look clearer on data that do not use overlay feature.

5. Text Data Search (Smart Search)

Once External device setup is finished, the Main Application will display text transmitted from external devices as the above screenshot. Each video and text data are recorded instantly, and data transmitted from external device can be searched directly using Smart Search.

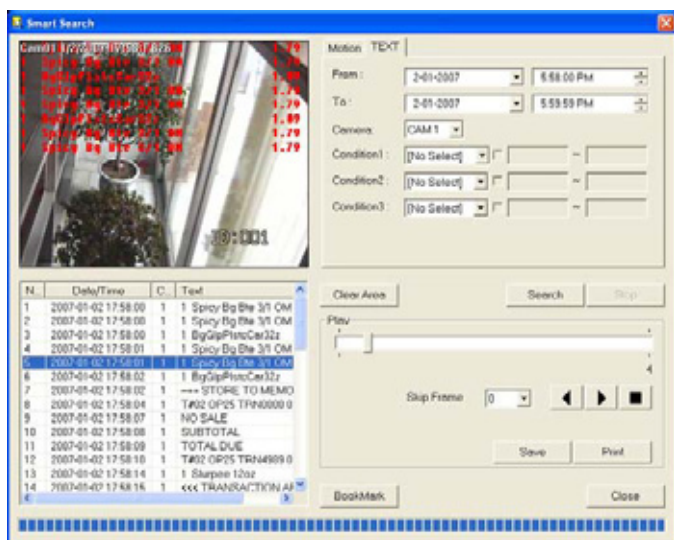

Select a date, time, and camera to begin the search. (From, To, Camera)

All data within the given range will be retrieved if search is performed with all conditions set as “No Select”

Images can be saved and printed.

Select “Full Text Search” and enter a text string as the following screenshot to search for data that corresponds to the text string.

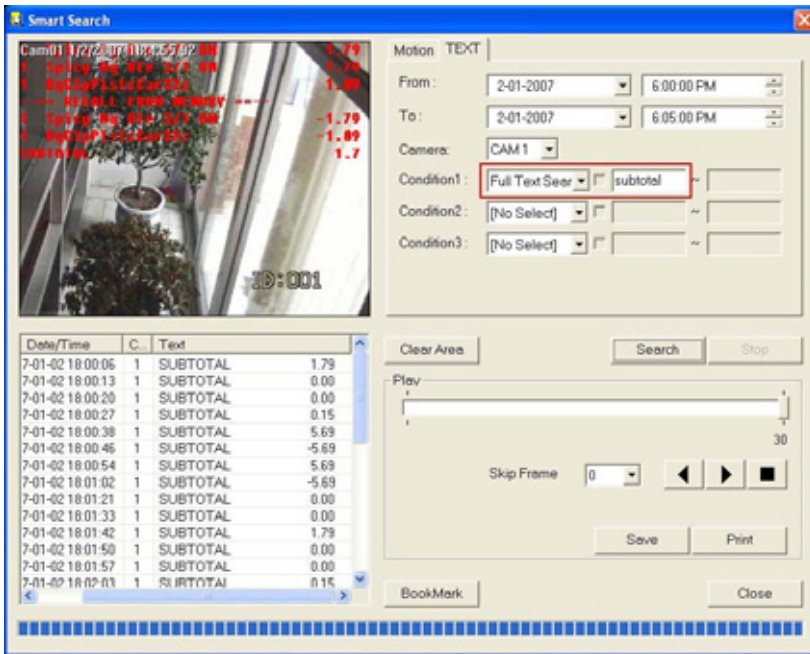

Select "Full Text Search" and enter a text string for each condition (Condition1, Condition2, Condition3) to search for data that correspond to all condition text string. (AND Operation)

Make a double click on an entry of the table that contains items found from the search to display a popup window as follows.

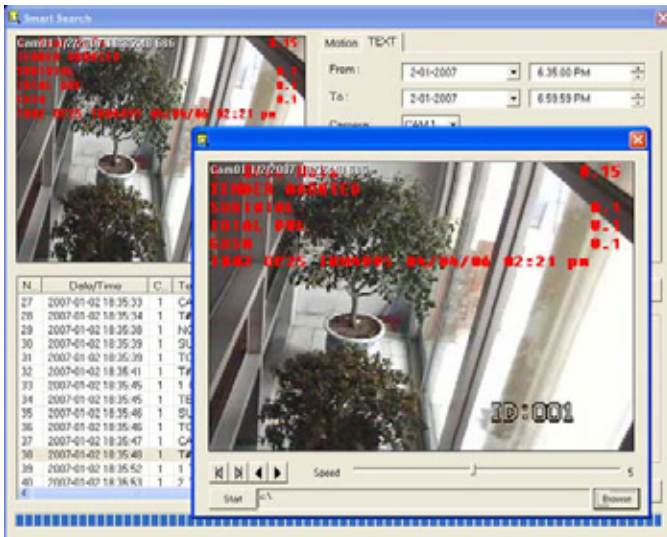

The window can be resized by clicking and dragging the corner with mouse. It supports searching features like frame by frame, playback, and AVI saving.

5-1. Item Search

If items were registered from the setting, then searches can be performed easily and quickly for each item. The following is an example of items set under Item Search.

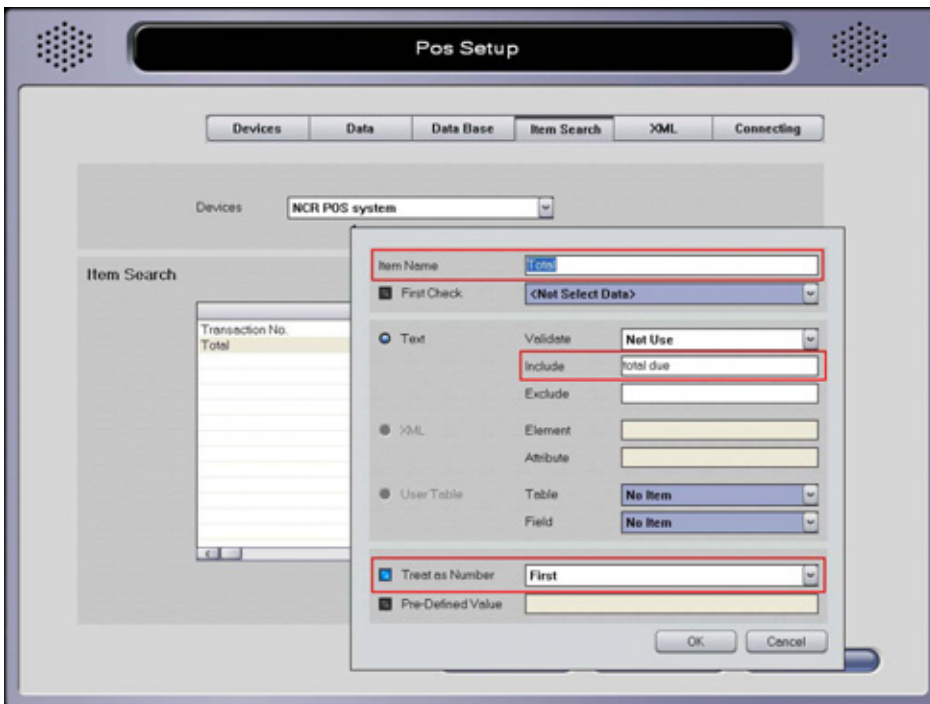
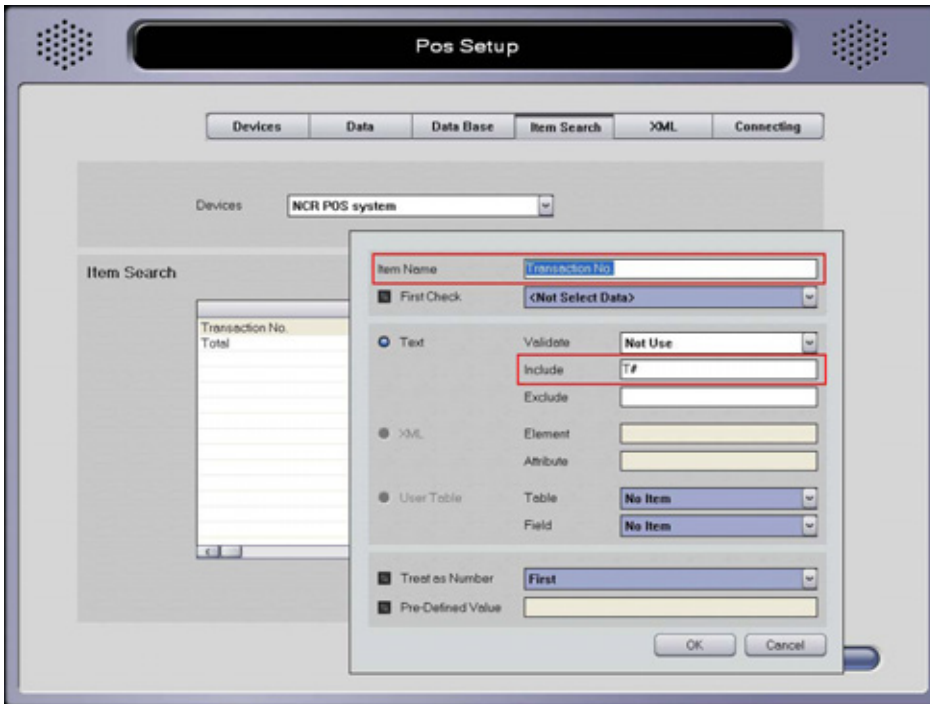

If items are registered as above, then the following item search can be performed on Smart Search.

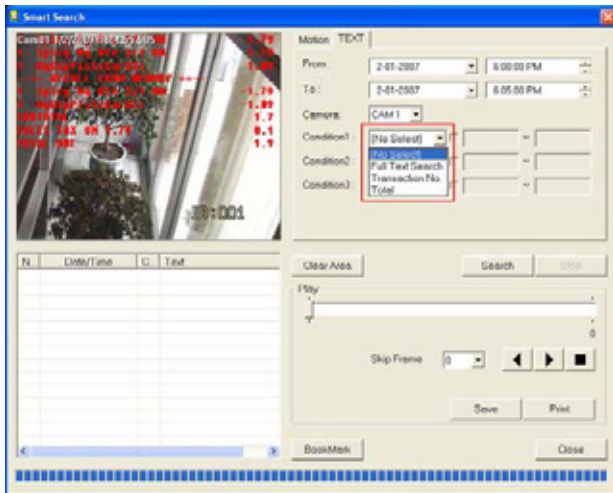

Registered items will be listed on the drop-down menu of each condition of the Smart Search.

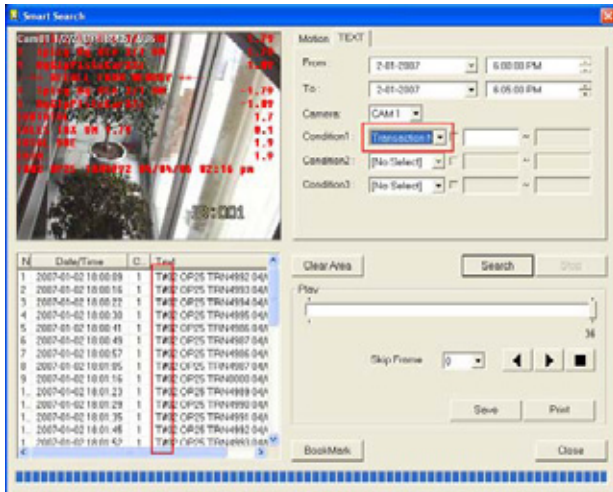

If a search is performed using "Transaction No.", then the search will list all data that contains the currently registered T# value.

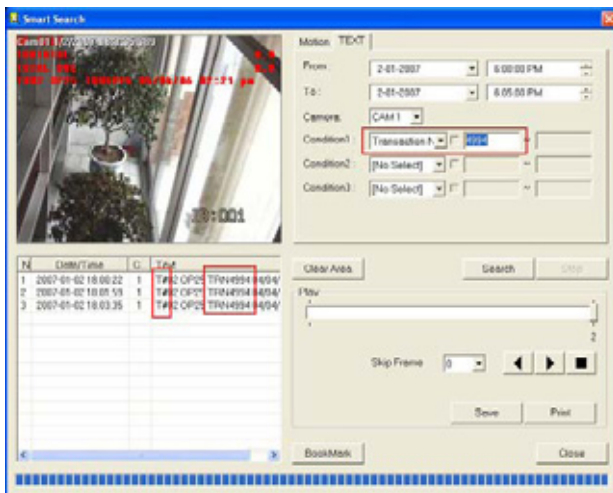

While performing search using "Transaction No.", a value (e.g. 4994) can be entered, which can be used to display data that contain 'T#' and '4994'

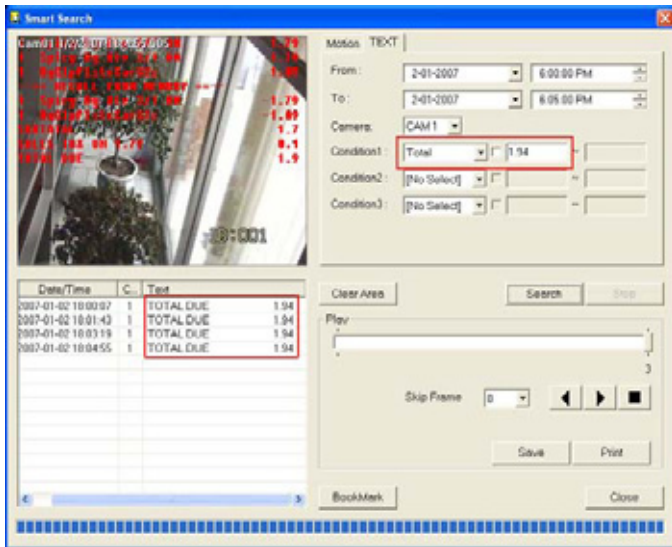

If search is performed using “Total”, then the search will list all entries with “Total Due” string.

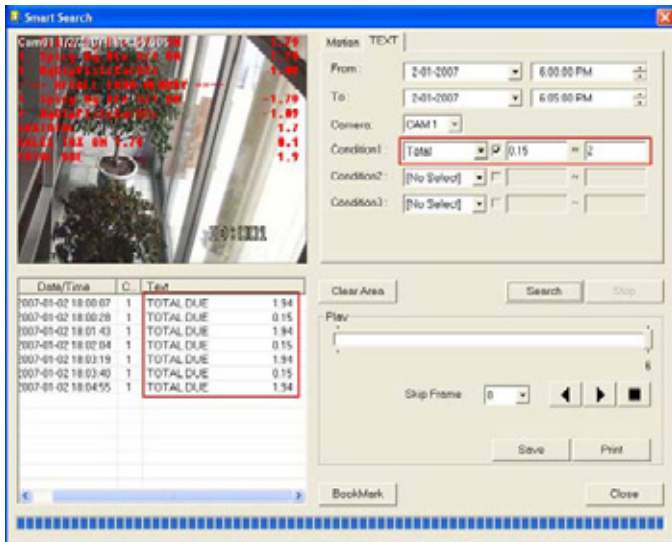

While performing search using “Total”, a value(e.g. 1.94) can be entered which can be used to display data that contain both “total due” and “1.94”

Check the checkbox that is located next to “Total” to perform a search within a range of values. (e.g. Entering “0.15~2” will only search data that corresponds to the given range of values.)

If the checkbox, located next to “Total”, is checked, entering only the value of:
 The first field will search any entries with equal to or higher value than the given value.
 The last field will search any entries with equal to or lesser value than the given value.
(Net Remote Smart Search requires both values)

* The search was able to retrieve data from a range of numerical values by recognizing the first text input as a numerical value because “Total” item was registered with “Treat as Number” option enabled and set as “First.” This is why check button is activated in Smart Search.

5-2. Item Search (XML)

POS, which transmits text based POS and XML data, has many different ways of setting up its behaviors with “Item Registration” and “Smart Search.”

The use of SQL Server 2005 as a database can replace the need for “User Table” by manually entering “Element” and “Attribute” in XML Configuration; however, User Table is required in the absence of the SQL Server 2005.

In case of using XML POS, when User Table is created, and Items are registered as following screenshot:



Parsing: Select a XSL Transformation file to make sure that only desired fields of XML data, transmitted from POS, will be displayed (Parsing is required when dealing with XML devices.)

Data Base is optional.

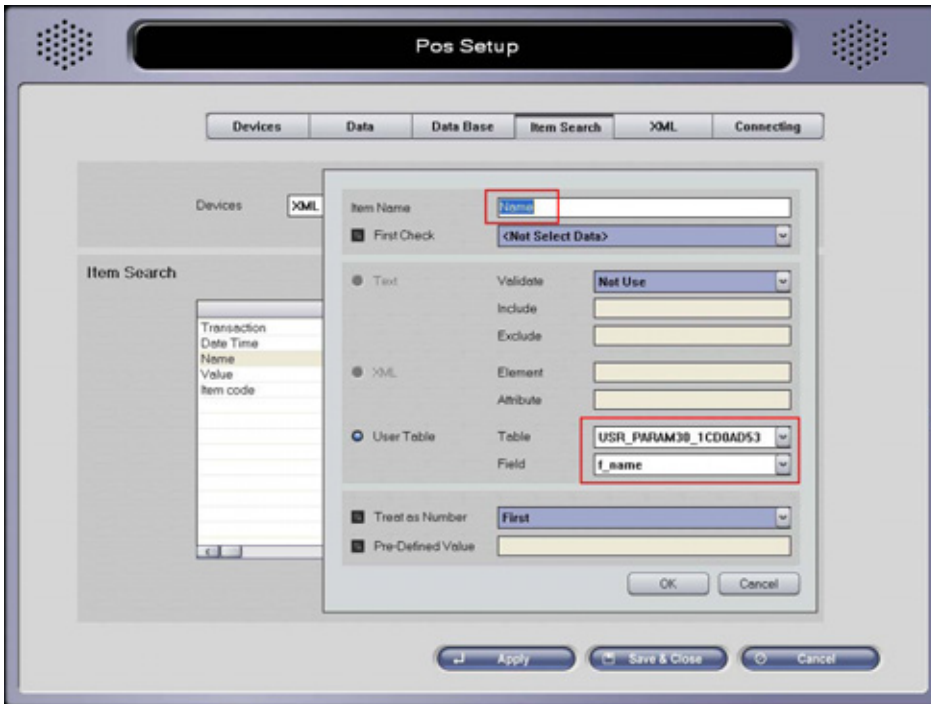
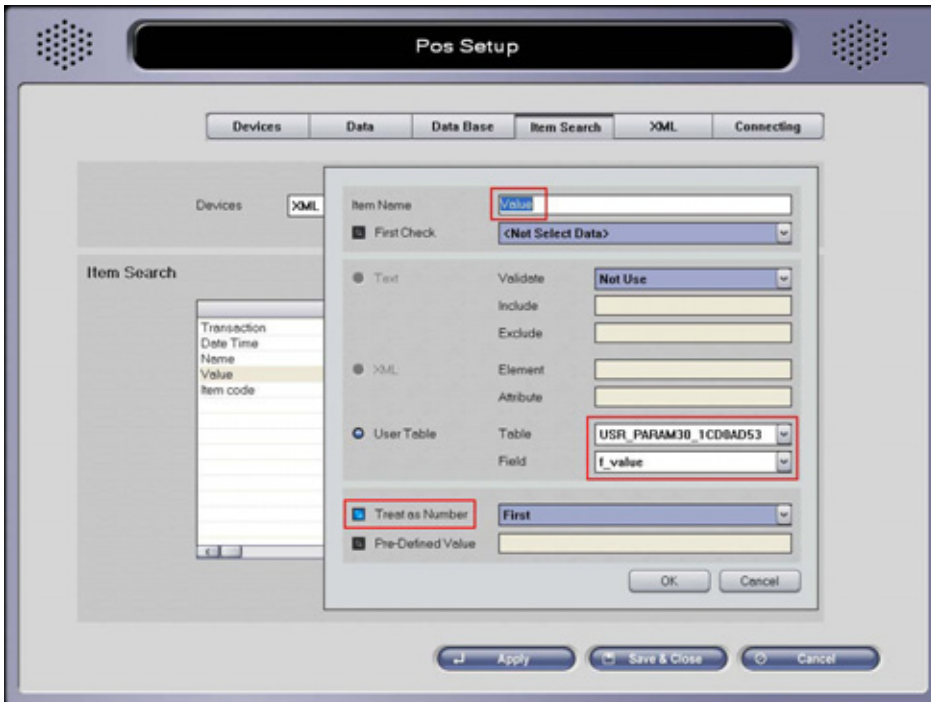
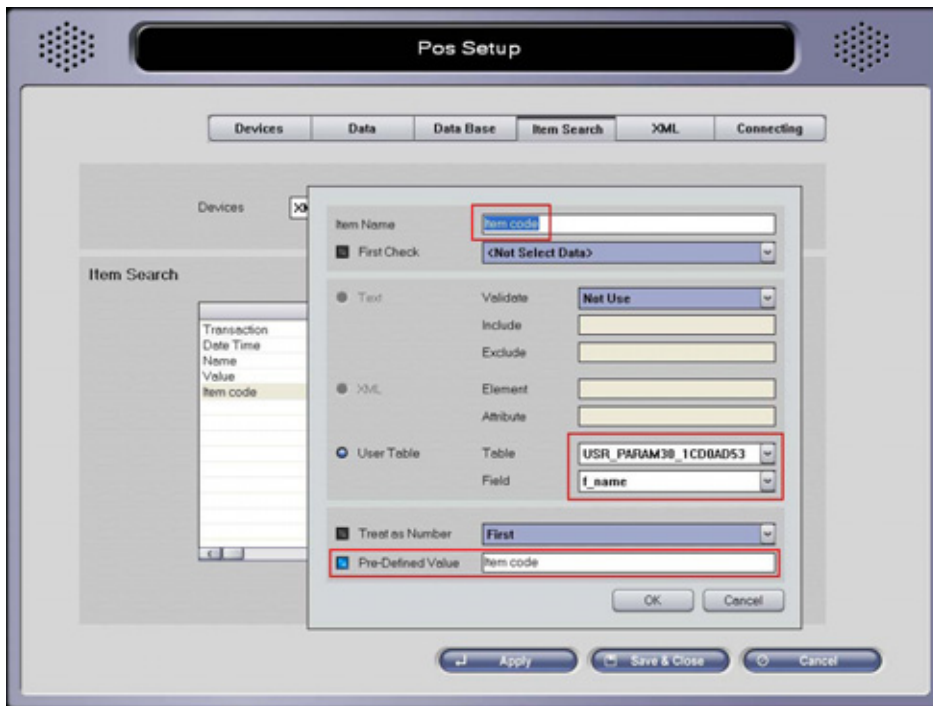

Table and Field will be allocated automatically when “User Table” is created, and “Item Name” will become an alias of “Field.” Data search performed by Smart Search will be retrieved from the given field.



“Treat as Number” field is checked to enable the use of numerical data in the “f_value” field for the search.



Enable “Pre-Defined Value” to enter the data value directly into the selected field and retrieve result from it.

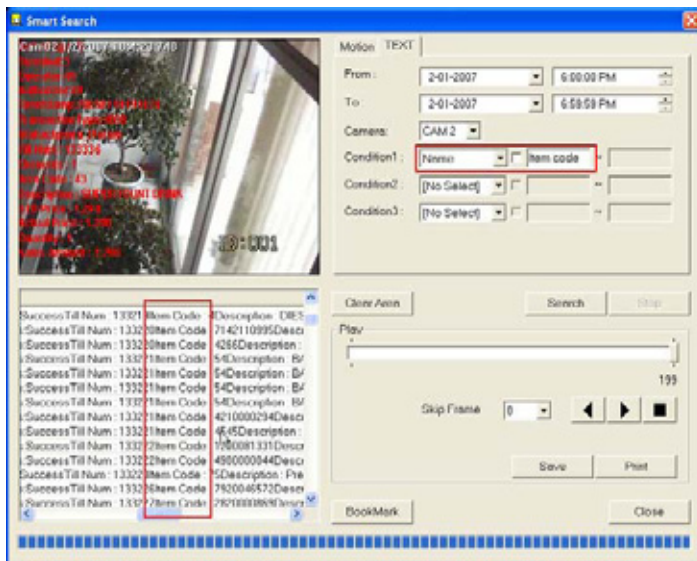

Retrieve “Item Code” from the field that corresponds to “Name.”

XML Characteristics -

Search cannot be performed using partial keywords in the field.

(e.g. “Item code” cannot be retrieved using a keyword like “Item”).

Even if an Item does not have “Treat as Number” feature enabled, all characters (including numbers) can be retrieved from a range of ASCII Codes.

5-3. DVR-Net / DVR-Web

Execute **Smart Search** remotely from **DVR-Net** Application.

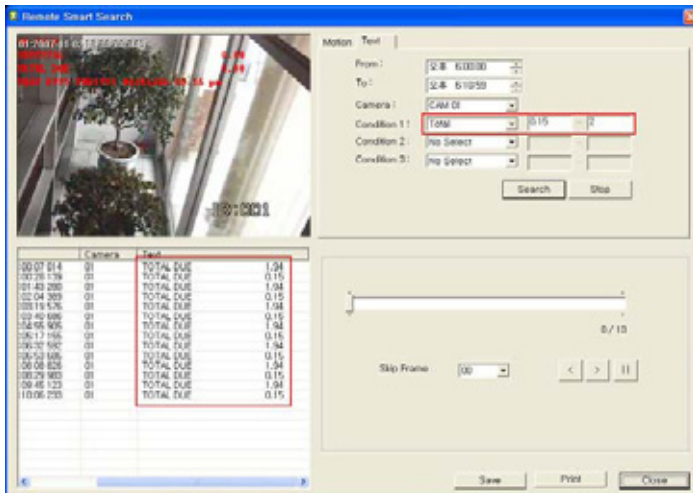

All Items registered from DVR are available, and its usage is identical to the Smart Search of DVR Main.

(Except that the Remote Search requires values in both fields (0.15 ~ 2) when searching within a range of data, whereas DVR requires only one of them.)

All data that corresponds to "Total" Item with a value between 0.15 and 2 (that is, such data will contain "total due" string and a value between 0.15 and 2) will be retrieved from DVR.

There might be a transmission delay depending on the network status.

Run Search from DVR-Web

“Text Search” button will appear if DVR system has POS patch installed.

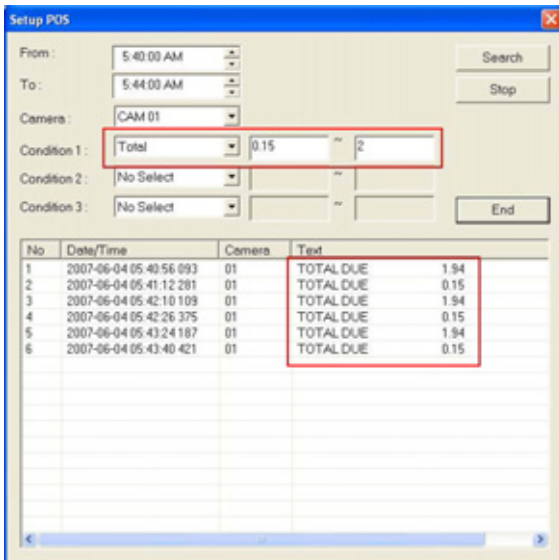
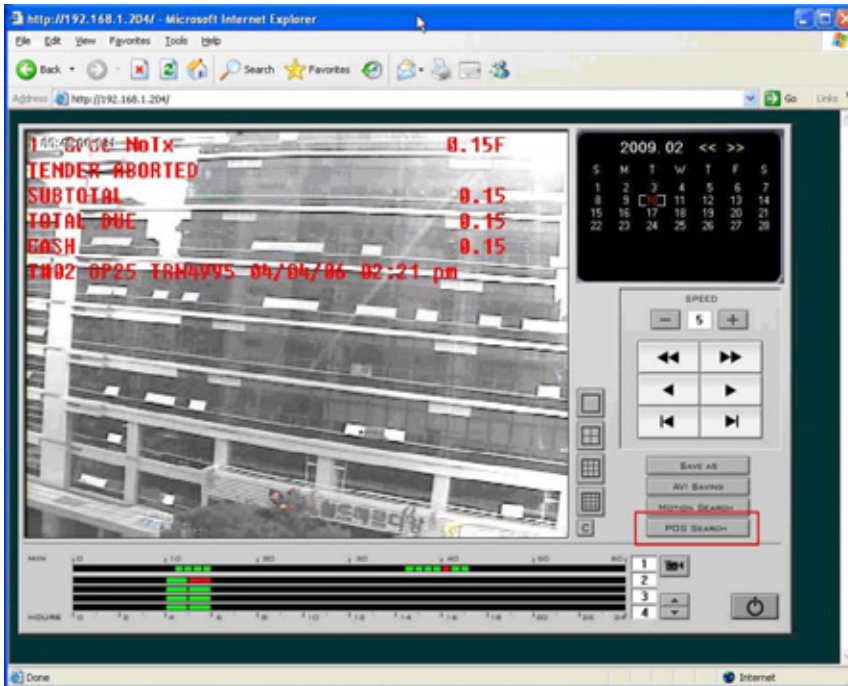

DVR All Items registered from DVR are available, and its usage is identical to the Smart Search of DVR Main.